

## PRODUCT INFORMATION

# HAMMAR ERRS

– ELECTRONIC REMOTE RELEASE SYSTEMS



# HAMMAR®

BETTER SOLUTIONS FOR SAFETY AT SEA

# SOLUTIONS THAT IMPROVE SAFETY, PERFORMANCE AS WELL AS ECONOMY

## THE HAMMAR REMOTE RELEASE SYSTEMS

Hammar Remote Release Systems are designed to release life rafts, evacuation systems and other lifesaving equipment on board vessels of all types, with the least possible effort. Whether you are a ship owner, designer, builder or onboard safety officer, Hammar Remote Release Systems offer flexible solutions with many decisive advantages – for both safety and economy.

With a remote release system, lifesaving equipment can be released from the bridge or other strategic locations on board. This means that in an emergency situation, you can save precious time. Furthermore, the release mechanism can be deployed irrespective of factors such as weather, smoke or fire, without the crew having to take any unnecessary risks. The systems can also be used for many other purposes. Closing doors and air intakes in case of fire, releasing heavy loads or maintenance equipment at remote or exposed locations onboard the ship.

Remote release systems not only improve safety on board, they also represent a sound economic investment. Life rafts can be positioned in remote locations on board and valuable deck space can be freed for passengers or cargo. You get a head start by planning for a remote release system from the initial design stage, but the systems can also be retrofitted. Since Hammar remote release systems are easy to handle, you can also minimize both crew and training costs.

Hammar Remote Release Systems require a minimum of maintenance and annual service. Follow the maintenance instructions and you will have a reliable safety system which can be depended on under critical and harsh situations.

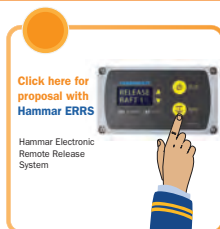

### Do you need help to choose your Remote Release System?

The Hammar Interactive Guide will help you to choose the right Hammar remote release system. The guide will lead you through a few essential questions. In the end it will give you a suggestion of which system to choose and which components to order. You find the guide at [www.cmhammar.com](http://www.cmhammar.com)

## I N D E X

About all ERRS Systems	3
Control Panel 2	5
BO	6
LAD	7
LRS	8
RS	9
Maintenance	10
Components	11
Technical Specification	15



## SAFETY

- The release mechanism can be deployed irrespective of parameters such as weather, smoke, fire or degree of list without the crew having to take unnecessary risks.
- With HAMMAR ERRS, lifesaving equipment can be launched more effectively and rapidly from remote positions on deck or from the bridge. This is an important safety aspect when time is crucial for the outcome of the situation.

## ECONOMY

- Since the system is easy to handle and more efficiently can launch safety equipment and managing fast evacuation of passengers you can minimize both crew and training costs.
- Liferafts and other systems for safety, emergency and evacuation can be hidden or positioned in remote located areas on board to free valuable deck surface for passengers or cargo to increase profitability

## PERFORMANCE

- By planning for the HAMMAR ERRS at an early stage, naval architects and designers can optimize the ship in terms of safety aspects, performance and design.
- To meet specific needs, most of the HAMMAR ERRS systems can be customized configured before delivery.
- Most of the HAMMAR ERRS can have several remote positions on the ship for releasing lifesaving appliances
- To guarantee functionality and reliability under all conditions most of the HAMMAR ERRS runs error detection programs and are equipped with a back-up battery if the ship's own emergency power supply goes down.

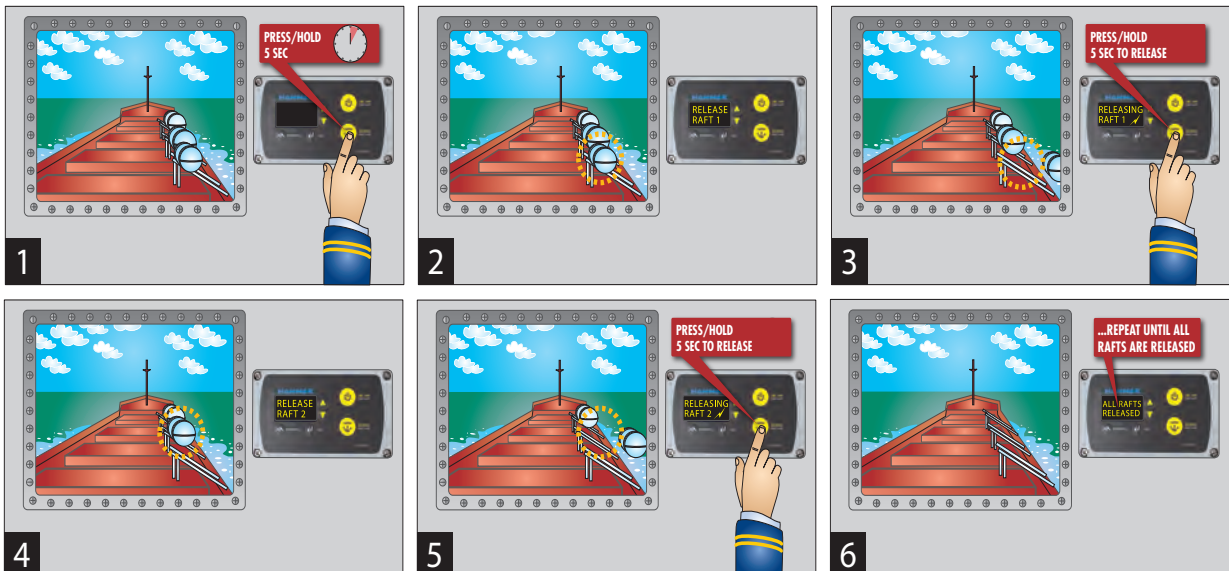

# ERRS - ELECTRONIC REMOTE RELEASE SYSTEM



## GENERAL INFORMATION

### Remote operated

Most of the HAMMAR ERRS can be operated from several remote release positions by adding one or more remote push buttons.

These units can activate H2O ERU (Electric Remote Unit) or relay outputs (depending on configuration). It is thus a very flexible system for the management of safety appliances on board.

### System checks

Most HAMMAR ERRS units automatically perform system checks; which monitors internal battery, emergency power voltage, ERU circuits and the wiring to external activation

switches. If the system check detects an error, an alarm message will appear on a display or on the LED indicator (depending on unit) and an alarm output is activated.

### Power supply

The ERRS system (excluding ERRS BO) is powered by the ship's 24 VDC emergency power supply. Each ERRS unit is also equipped with a back-up battery to enable operation even if the ship's power supply is down.

The systems are designed to be user friendly, require a minimum of maintenance and easy to install, even for retrofit.

### Control Panel 2

Flexible system with several in- and outputs for safety appliances

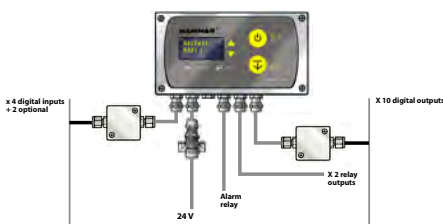

### Battery operated system - BO

No external power supply is needed

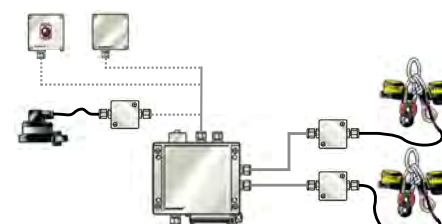

### List Angle Detection - LAD

List angle activation of liferafts

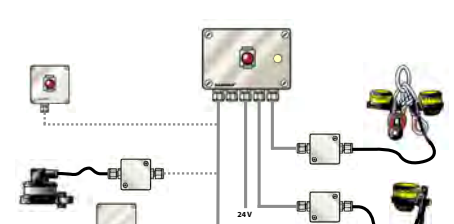

### Local release system - LRS

Remote release system for few liferafts

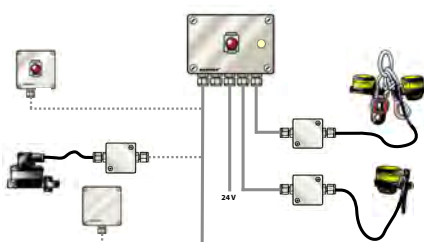

### Release switch - RS

Remote release system for one liferaft

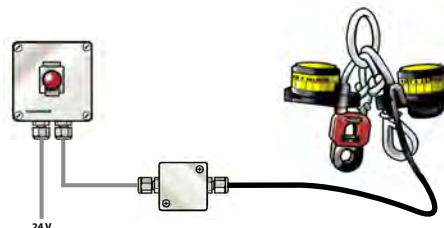

# ERRS CONTROL PANEL 2

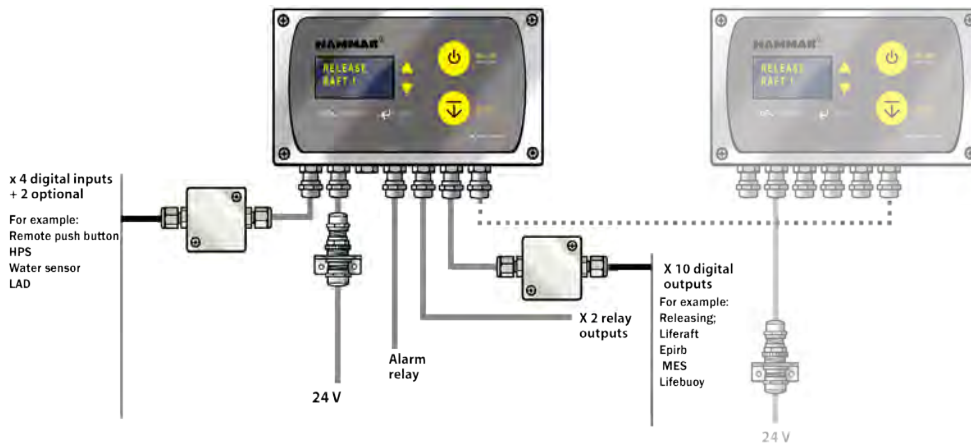

**HM-0710**  
 Outputs: 10 digital + 2 relays  
 Inputs: 4 + 2 optional  
 Backup-battery: Rechargeable, up to 20 hours operating time

**Features**

- Customized configuration before delivery
- Several Electric Release Units or relay outputs can release lifesaving appliances in pre-programmed sequences or by manual selection.
- Sensors, switches and push buttons connected to the ERRS Control Panel 2 inputs can initiate activation on the outputs.

**Especially suitable for**

For ships and vessels demanding a very flexible system with customized solutions for activation of several lifesaving appliances, evacuations systems or loads.

**System set-up**

The configuration of the ERRS Control panel 2 is very flexible and each installation has its own configuration parameters. The system is operated from one or several ERRS Control Panels in a network. The panels can activate outputs to release ERU’s (Electric Release Units) for launching liferafts, evacuation systems, Epirbs and other safety equipment. The relay outputs can also be used for closing doors and air intakes in case of fire, set an alarm or release heavy loads. Activation of these outputs can also be controlled from other remote positions by using pushbuttons and remote switches connected to the

network via the inputs. The performance of the system is defined by the customized configuration of the ERRS Control Panel 2. Due to how it is programmed, the system can meet specific requirements for each installation.

**Outputs**

Outputs can be activated from one or several ERRS Control Panel 2 or from added devices connected to the panels' inputs. The system can be configured to activate in forced manual sequence, forced automatic sequence, combination of these or by manual selection of available outputs or groups of outputs. Each panel has 10 outputs for releasing H2O ERU (Electronic release unit), 2 relay outputs and 1 alarm relay output.

**Inputs**

Every ERRS Control Panel 2 has 4 inputs (closing contact) with possibility to have broken wire detection and 2 optional isolated inputs. Different types of sensors, remote push buttons and switches can be connected to the inputs. When an input is activated, the Control Panel 2 can activate outputs or relays for initiate an action or a sequence of actions, for example launching liferafts, activate a MES or set an alarm.

**System check**

ERRS Control Panel 2 continuously runs system check to detect errors in the system. The system check monitors the internal back-up battery and emergency power voltage, ERU circuits and communication between panels in the network. If the system check detects an error, an alarm message will appear on the display. A LED will indicate 24 VDC emergency power failure.

Products		External power supply	Backup battery	Inputs	Outputs	Alarm output	Activation sequence between outputs	System check
Part no.	Part							
HM-0710	Control Panel 2	Emergency power 24V	Yes	4+2	10+2	Yes	Configured at delivery	Continuously
HM-0460	BO	No	Yes	1	2	No	Different configuration available	Manual
HM-0461	LAD	Emergency power 24V	Yes	1	2	Yes	Different configuration available	Once every hour
HM-0462	LRS	Emergency power 24V	Yes	1	2	Yes	Different configuration available	Once every hour
HM-0450	RS	Emergency power 24V	No	0	1	No	No	No

# ERRS BO - BATTERY OPERATED SYSTEM

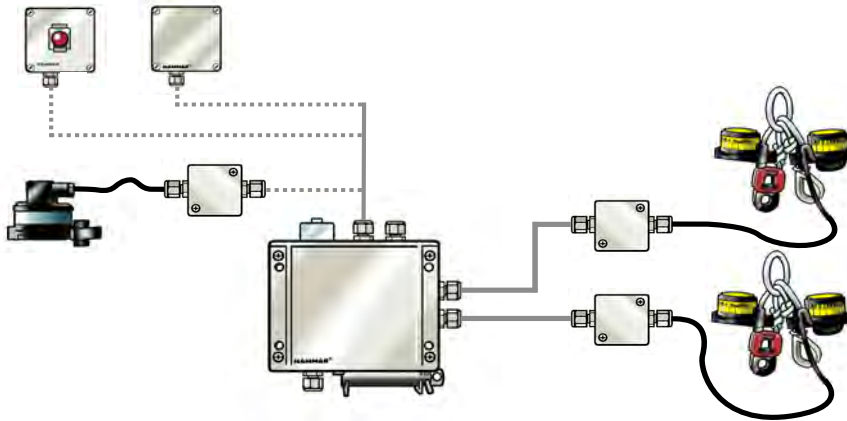

## HM-0460

Outputs: 2

Inputs: 1

Backup-battery: Up to 24 hours operating time

### Features

- ERRS BO is powered by the integrated battery, therefore it operates without external power supply from the ship
- The standard configuration is set to release the two units (liferafts, EPIRBS) at the same time. Different configurations are available.

### Especially suitable for

Solutions demanding electronic remote system with no access to external power supply.

The system has an integrated Lithium battery pack with 5 years lifetime. The ERRS BO system is normally in a sleeping mode to save battery and the system needs to be waked up before use by removing an activation bar. ERRS is powered by the integrated battery and can be used for installations up to 150 meters in cable length.

### In- and outputs

It is operated by a remote push button, a water sensor or by a HPS Hydrostatic Pressure Switch that activates one or two electric Hammar H2O Electric Remote Unit's. ERRS BO can be controlled from several remote release positions by adding one or more remote push buttons.

### System check

ERRS performs a system check when the test push button is pressed. The system check monitors battery, ERU circuits and the wiring to an external activation switch. If the system check detects a deviation an alarm message will appear on the LED indicator.

Products		External power supply	Backup battery	Inputs	Outputs	Alarm output	Activation sequence between outputs	System check
Part no.	Part							
HM-0710	Control Panel 2	Emergency power 24V	Yes	4+2	10+2	Yes	Configured at delivery	Continuously
HM-0460	BO	No	Yes	1	2	No	Different configuration available	Manual
HM-0461	LAD	Emergency power 24V	Yes	1	2	Yes	Different configuration available	Once every hour
HM-0462	LRS	Emergency power 24V	Yes	1	2	Yes	Different configuration available	Once every hour
HM-0450	RS	Emergency power 24V	No	0	1	No	No	No

# ERRS LAD - LIST ANGLE DETECTION

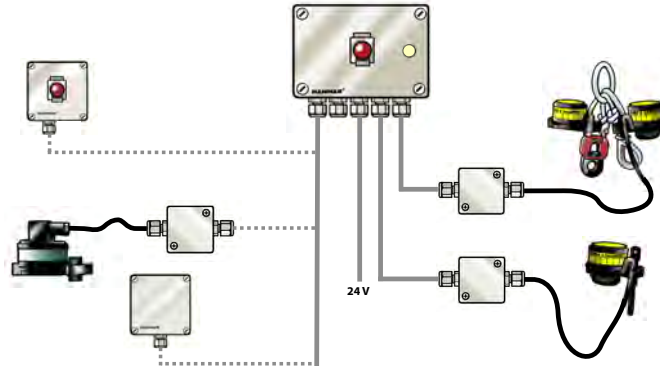

## HM-0461

Outputs: 2

Inputs: 1

Backup-battery: Up to 12 hours operating time

### Features:

- Automatically release of units at a specified degree of list
- Different configuration of the list angle and different activation sequences of outputs are available.
- Can also release units manually by local or remote push button

### Especially suited for

Vessels with increased risk of capsize due to working conditions such as fishing vessels, workboats.

With current float-free release systems on the market, safety equipment is released first when it reaches a depth of 1,5 to 4 metres. When a ship or a vessel capsizes without sinking, there is therefore a risk that liferafts and Epirbs are trapped under the vessel, or never released at all if not submerged to a sufficient water depth.

With List Angle Detection (LAD) liferafts and Epirbs can be automatically released at a specified degree of list when a vessel capsizes. The released safety units reach the surface before the ship flips around, significantly reducing the risk for it to be trapped or entangled in constructions on deck.

### In- and outputs

ERRS LAD can be controlled from several remote release positions or automatically by a HPS (Hydrostatic Pressure Switch) or a water sensor. Output number two is activated automatically 2 seconds after output number one has been activated as a standard configuration. For activation of relay outputs the unit has to be configured for this function and an ERRS Addon modul (HM-0464) is needed.

### System check

ERRS LAD automatically performs a system check once every hour. The system check monitors battery, emergency power voltage, ERU circuits and the wiring to an external activation switch. The battery condition is checked every 24 hours. If the system check detects a deviation an alarm message will appear on the LED indicator and the alarm output is activated. It is possible to initiate a manual system check which is useful at raft service.

### Power supply

ERRS is powered by the ship's emergency power supply. Each control panel is also equipped with a back-up battery to ensure operation in all emergency conditions.

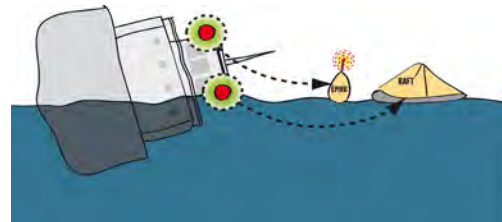

Products		External power supply	Backup battery	Inputs	Outputs	Alarm output	Activation sequence between outputs	System check
Part no.	Part							
HM-0710	Control Panel 2	Emergency power 24V	Yes	4+2	10+2	Yes	Configured at delivery	Continuously
HM-0460	BO	No	Yes	1	2	No	Different configuration available	Manual
HM-0461	LAD	Emergency power 24V	Yes	1	2	Yes	Different configuration available	Once every hour
HM-0462	LRS	Emergency power 24V	Yes	1	2	Yes	Different configuration available	Once every hour
HM-0450	RS	Emergency power 24V	No	0	1	No	No	No

# ERRS LRS - LOCAL RELEASE SYSTEM

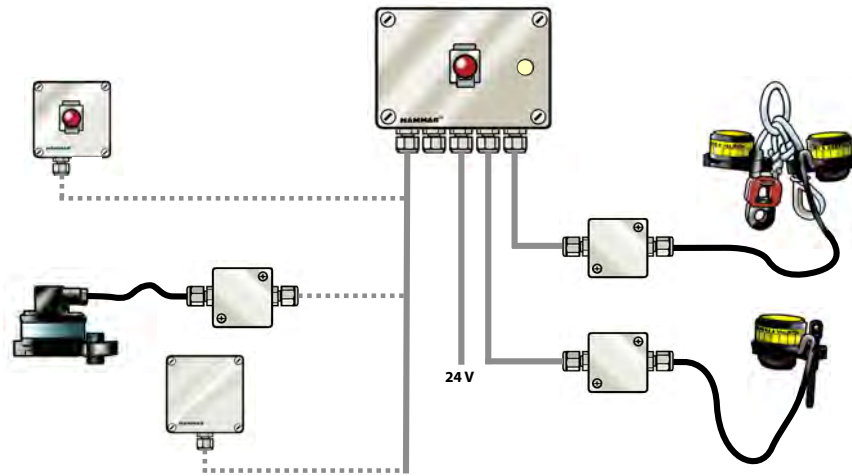

## HM-0462

Outputs: 2

Inputs: 1

Backup-battery: Up to 24 hours operating time

### Features

- Release system for two units with adjustable time delay
- Possible to release units both manually by push button or automatically by a HPS

### Especially suitable for

Optimized for installation with few liferafts and/or EPIRBS.

ERRS LRS is easy to operate and install, saves space and is very flexible, thus providing effective management for fast evacuation of a large number of passengers. ERRS LRS can be used for installations up to 150 meters in cable length.

### In – and outputs

ERRS LRS is operated by a push button on the electronic control panel that activates one or two electric Hammar H20 Electric Remote Unit´s or relay outputs. Output number two is activated automatically 2 seconds after output number one has been activated as a standard configuration. The time delay can be adjusted to meet specific requirements. For activation of relay outputs an ERRS Addon modul (HM-0464) is needed and the unit has to be configured for this function.

The system can be controlled from several remote release positions by adding one or more remote push buttons. It is thus a very flexible system for the management of safety appliances on board.

### Power supply

ERRS is powered by the ship's emergency power supply. Each control panel is also equipped with a back-up battery to ensure operation in all emergency conditions. The system can run on battery for 24 hours if the ship's emergency power supply is interrupted.

### System check

ERRS automatically performs a system check once every hour. The system check monitors battery, emergency power voltage, ERU circuits and the wiring to an external activation switch. The battery voltage is checked every 24 hours. If the system check detects a deviation an alarm message will appear on the LED indicator and the alarm output is activated. It is possible to initiate a manual system check which is useful at raft service.

Products		External power supply	Backup battery	Inputs	Outputs	Alarm output	Activation sequence between outputs	System check
Part no.	Part							
HM-0710	Control Panel 2	Emergency power 24V	Yes	4+2	10+2	Yes	Configured at delivery	Continuously
HM-0460	BO	No	Yes	1	2	No	Different configuration available	Manual
HM-0461	LAD	Emergency power 24V	Yes	1	2	Yes	Different configuration available	Once every hour
HM-0462	LRS	Emergency power 24V	Yes	1	2	Yes	Different configuration available	Once every hour
HM-0450	RS	Emergency power 24V	No	0	1	No	No	No



# ERRS RS - RELEASE SWITCH

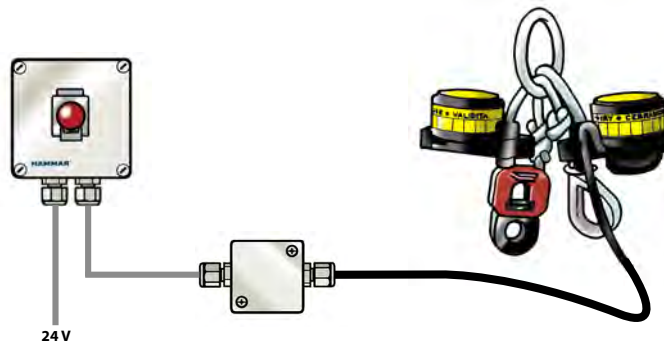

## HM-0450

Outputs: 1  
Inputs: 0  
Backup-battery: None

## HM-0451

Outputs: 1  
Inputs: 0  
Backup-battery: None  
For flush mounting, consist of a push button module and an electronic switch module

## HM-0453

Outputs: 1  
Inputs: 0  
Backup-battery: None  
Parallell connection with HM-0460, HM-0461, HM-0462

### Features:

- Release system for one unit, such as liferaft, Epirb, lifebuoy
- Easy to operate and install

### Especially suitable for:

Optimized for release of one liferaft, Epirb, lifebuoy or other objects secured on deck.

This is the simplest HAMMAR ERRS system with the capacity to release one ERU with the pushbutton on the Electric Release Switch.

The unit is powered by the ship's 24 V emergency power. There is no backup battery.

Products		External power supply	Backup battery	Inputs	Outputs	Alarm output	Activation sequence between outputs	System check
Part no.	Part							
HM-0710	Control Panel 2	Emergency power 24V	Yes	4+2	10+2	Yes	Configured at delivery	Continuously
HM-0460	BO	No	Yes	1	2	No	Different configuration available	Manual
HM-0461	LAD	Emergency power 24V	Yes	1	2	Yes	Different configuration available	Once every hour
HM-0462	LRS	Emergency power 24V	Yes	1	2	Yes	Different configuration available	Once every hour
HM-0450	RS	Emergency power 24V	No	0	1	No	No	No

# MAINTENANCE

## ERRS CONTROL PANEL 2

### ERRS Control Panel 2

ERRS Control Panel requires a minimum of maintenance: If the battery control test indicates insufficient battery capacity, replace the battery.

### Change H20 ERU

The H20 ERU is a disposable unit, it has to be changed to a new one every second year (see the expiry date on the H20 ERU).

**MAKE SURE THE LIFERAFTS ARE SECURED BEFORE ANY WORK WITH THE RELEASE UNITS TAKE PLACE!!**

### System status check

The ERRS Control Panel 2 control shall be visually inspected on a regular basis to make sure that the systems status is OK. We recommend that the alarm output is connected to a siren, a light or to the ship general alarm system.

---

## BO, LAD, LRS

### Control box

The Control box requires a minimum of maintenance: replacing the backup battery every 5 years or when it has been in use or if a low battery voltage alarm is shown.

### Change H20 ERU

The H20 ERU is a disposable unit, it has to be changed to a new one every second year (see the expiry date on the H20 ERU).

**MAKE SURE THE LIFERAFTS ARE SECURED BEFORE ANY WORK WITH THE RELEASE UNITS TAKE PLACE!!**

### System status check

The System status check automatically checks the function of the system. The system status is shown on a LED indicator and the control boxes shall be visually inspected on a regular basis to make sure that the systems status is ok. We recommend that the alarm output is connected to a siren, a light or to the ship general alarm system.

# ERRS SYSTEM COMPONENTS

## ERRS SYSTEM

Part no.

HM-0710 Control Panel 2 can handle up to 10 active outputs, two relay outputs, 4 active inputs and two optional inputs. OLED display. Each Control panel will be configured for each installation. Contains electronics, back-up battery and terminal block.



HM-0460 Control Box BO – battery operated. Two active outputs and one input for hydrostatic pressure switch – HPS or remote push button. Battery operated and 5 years lifetime. LED status feedback.



HM-0461 Control Box LAD – list angle detection system. Two active outputs and one input for hydrostatic pressure switch – HPS or remote push button. 24V emergency power. Battery backup with 5 years lifetime.



HM-0462 Control Box LRS – local release system. Two active outputs and one input for hydrostatic pressure switch – HPS or remote push button. 24V emergency power. Battery backup with 5 years lifetime.













HM-0450 Release switch for ERU. Can handle one active output. Powered by 24V emergency power.



## ERRS INPUT COMPONENTS

Part no.

HM-0470	HPS – hydrostatic pressure switch. Activates at 1,2m water depth. Other release depth is available on request. Cable length is 1,5m.		HM-0451	Release switch for ERU for flush mounting. Supplied without protective enclosure.	
HM-0475	Protective enclosure for HPS switch		HM-0452	Intelligent remote push button IRPB, one active contact, input to HM-0710. IRPB is included in the Control Panel 2 system check.	
HM-0474	HPS – hydrostatic pressure switch. Activates at 1,2m water depth. 35cm cable with connector size 10. Other release depth is available on request.		HM-0453	Remote push button, one active contact, parallel connection with HM-0460, HM-0461 or HM-0462	
HM-0476	Protective enclosure, HPS switch with cable connector.				
HM-0478	Water sensor. Activates at the presence of bulk water and will not activate due to moisture or rain.				
HM-0479	Enclosure for water sensor. Protects the water sensor from abuse or splashes of water.				
HM-0450	Release switch RS, for ERU. Can handle one active output. Powered by 24V emergency power.				

**ERRS OUTPUT COMPONENTS**

Part no.

HM-0400 ERU – electric remote unit, electric activation only



HM-0493 Polar Box heated for two ERU



HM-0405 ERU – electric remote unit, electric/water activation, release depth 1,5 – 4,0 metres



HM-0408 ERU – electric remote unit, electric/water activation, release depth approx. 4 metres



HM-0403 ERU – electric remote unit, electric/water activation, release depth approx. 6 metres



HM-0409 ERU-electric remote unit, electric/water activation, release depth 1,5 – 4,0 metres, for EPIRB



HC-0402 H2O/ERU dual assembly, Hammar type for rafts in MES system, weak link, electric activation only



HC-0403 H2O/ERU dual assembly, Hammar type for rafts, standard weak link, electric/water activation, release depth 1,5 – 4,0 metres



## ERRS INSTALLATION COMPONENTS

Part no.

HM-0464	ERRS Addon modul to HM-0461 and HM-0462 – offers connection in parallel between several Control Boxes plus offers the possibility for relay output.		HM-0735	Ground connection device M25 cable dia 12 – 18mm, shall be used with HM-0710	
HM-0430	ERU connector box, plastic		HM-0457	ERRS simulator for ERRS Control System	
HM-0420	ERU connector box, metal				
HM-0426	ERU connector box, plastic, for two ERU's		HM-0458	ERRS simulator for ERRS BO Control System	
HM-0434	Cable between control panels, marine approved, screened 2x2x0,5 mm <sup>2</sup>		HM-0446	Dummy for battery Control Panel HM-0410 (bild senare)	
HM-0436	Cable from control panel to release switch, marine approved screened 4x0,75 mm <sup>2</sup>		HM-0467	ERU emulator for ERRS, test device for installation of ERRS systems	
HM-0440	Cable from control panel to connector box, marine approved, screened 2x0,75 mm <sup>2</sup>				
HM-0730	Ground connection device M20 cable dia 6 – 12mm, shall be used with HM-0710				

**ERRS SPARE PARTS**

Part no.

HM-0415 Control panel, toplid only



HM-0445 HM-0445 Battery pack, backup, 12V lithium, for Panel System HM-0410



HM-0495 Battery pack, backup, 12V Lithium, for HM-0460, HM-0461, HM-0462



HM-0448 External battery pack for ERRS Control Panel (old version) HM-0410



HM-0442 Earth cable, for HM-0410



HM-0725 Rechargeable battery pack for Control Panel 2, HM-0710



HM-0486 Magnetic activation bar for Control Box BO



# TECHNICAL SPECIFICATIONS

## ERRS CONTROL PANEL 2 - HM-0710

### TEMPERATURE RANGE

ERRS Control Panel 2 operates between -30 C to +65 C

### INTERNATIONAL PROTECTION RATING

Control panel: IP 66

Connector boxes for H20 ERU: IP 66

Colour: Steel grey

### WEIGHT

ERRS control panel 2: 2800 gram

Connector box for H20 ERU: 150 gram

### DIMENSIONS

L x H x D: 222 x 125 x 84 mm

### POWER SUPPLY

Main source: 24 VDC max 0,5 A (16-36 VDC)

Rechargeable back up battery: Pb, 6 VDC

### I/O

Inputs: 4 (closing contacts) with broken wire detection

Isolated Inputs: 2

Outputs: 10 (for H20 ERU release units)

Relay outputs: 2

Alarm relay output: 1 (normally closed when system ok)

### USER INTERFACE

Display: OLED display - size 63x33 mm

Membrane switch: 6 buttons

### CABLES

Cable for communication between Control Panels – HM-0434

2 x 2 x 0,5mm<sup>2</sup>, diameter 12mm

Cable from Control Panel to Release Switch – HM-0436

2 x 2 x 0,75mm<sup>2</sup>, diameter 10mm

Cable from Control Panel to connector box – HM-0440

1 x 2 x 0,75mm<sup>2</sup>, diameter 8mm

General specification: Marine approved, screened. If the cable is sourced locally it is important that the same quality and dimensions are used. Use of larger diameter cable will not fit the cable glands.

**Note:** Check electric wiring drawing.

### CABLE GLANDS

#### Standard Equipped

16 x M16 metal EMC Cable Glands for cable diameter 5,0 -10,0 mm, screen diameter 3,5-8,0 mm

2 x M20 metal EMC Cable Gland for cable diameter 7,5 – 14,0 mm, screen diameter 5,5-11,0 mm

### Optional cable glands

6 x M16 x 1,5 Cable Gland for cable diameter 8,0 – 15,0 mm, screen diameter 7,5-10,0 mm

4 x M16 EMC Cable Gland for cable diameter 6,0 – 10,5 mm, screen diameter 4,5-8,0 mm

2 x M20 x 1,5 EMC Cable Gland for cable diameter 8,0 – 15,0 mm, screen diameter 7,5-12,0 mm

1 x M20 EMC Cable Gland for cable diameter 12,5 – 20,5 mm, screen diameter 10,0-16,0 mm

### CONFIGURATION

N° of release objects (liferrafts). Display text/language/sequence. All parameters are programmed into the system by C M Hammar upon delivery. There are several possibilities to further adapt the system. Please consult us for special requirements.

### CONNECTION TERMINALS

Max. wire area 2,5 mm<sup>2</sup>

### ERRS CONTROL PANEL 2 SPECIFICATION

The maximum wire length between each control panels is 1000 meters.

The maximum wire length between a control panel and its connected H20 ERU is 150 meter.

Up to 8 control panels can be connected in a network giving a maximum of 80 H20 ERU outputs, 16 relay outputs and 48 inputs for the complete network.

**Note:** Check electric wiring drawing.

### SYSTEM TEST

The system continuously runs a system check for battery, power supply, H20 ERU, cables and for the panel communication.

An error relay output can be connected to any external alarm system.

System error is shown on the display or by the led indicator.

### DOCUMENTATION

Product leaflet, Technical Product Information & Installation Manual

### GROUND CONNECTION DEVICE

The device is designed to ensure a good permanent electrical connection between the ERRS Control Panel 2 system and to the ships ground. Each ERRS Control Panel 2 has to be connected to ships ground.

The Ground Connection Device is available in two sizes for different cable diameters.

**Ground connection device M20** for cables diameter of 6 -12 mm, screen diam. 4,5 – 10 mm. Part no: HM-0730

**Ground connection device M25** for cables diameter of 12 – 18 mm, screen diam. 7 – 14 mm. Part no: HM-0735



## BO, LAD, LRS, RS

### TEMPERATURE RANGE

System and its components: -30° C to +65° C

### INTERNATIONAL PROTECTION RATING

IP66

Material: BO Alloy; LAD, LRS, RS glass fibre reinforced duroplastic polyester.

Colour: BO; Steel grey. LAD, LRS, RS beige/grey

Flammability: V0/self-extinguishing, UL 94

Toxity: Halogen free

### WEIGHT

**BO** - 800gr

**LAD** - 1950gr

**LRS** - 1900gr

**RS** - 515gr

**RS Flush mount** - 125g

### USER INTERFACE

Gives feedback from the system status check and feedback at activation by a three colored LED.

### CABLES

Screened wires with a minimum wire area of 0.75 mm<sup>2</sup> shall be used. Maximum cable length 150 meters.

Products		External power supply	Backup battery	Inputs	Outputs	Alarm output	Activation sequence between outputs	System check
Part no.	Part							
HM-0710	Control Panel 2	Emergency power 24V	Yes	4+2	10+2	Yes	Configured at delivery	Continuously
HM-0460	BO	No	Yes	1	2	No	Different configuration available	Manual
HM-0461	LAD	Emergency power 24V	Yes	1	2	Yes	Different configuration available	Once every hour
HM-0462	LRS	Emergency power 24V	Yes	1	2	Yes	Different configuration available	Once every hour
HM-0450	RS	Emergency power 24V	No	0	1	No	No	No

# ERRS ENCLOSURE DIMENSIONS

## HM-0710 Control Panel 2

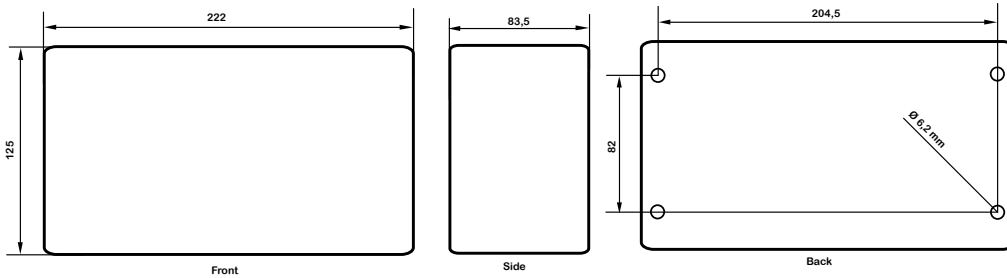

## HM-0475 Protective enclosure for HPS switch

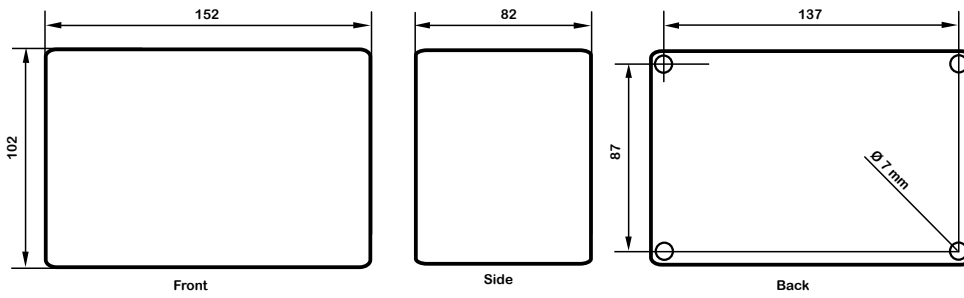

## HM-0426 ERU connector box, plastic, for two ERU's

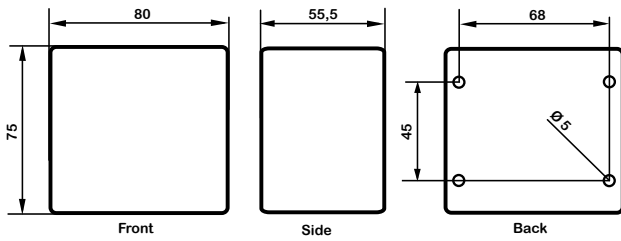

## HM-0451 Release Switch for flush mounting

### Push button module

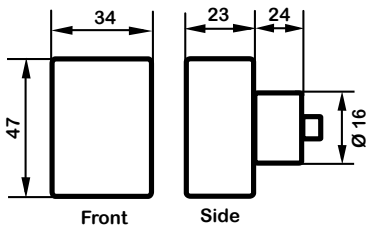

### Electronic module

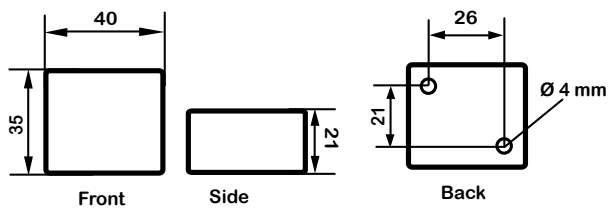

## HM-0450 Release Switch

## HM-0452 Intelligent Remote Push button

## HM-0453 Remote push button

## HM-0454 Remote push button, 2 glands

## HM-0478 Water sensor

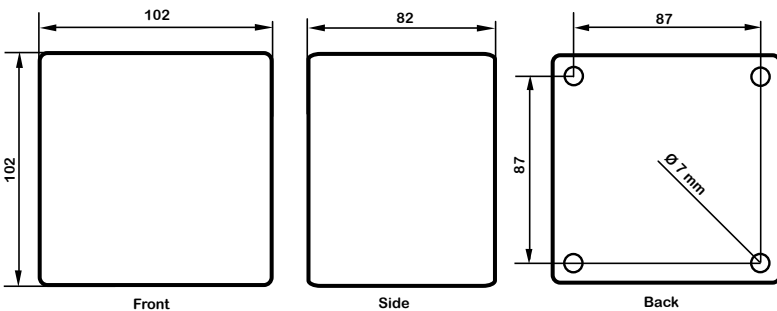

**HM-0460 B0 Control box**

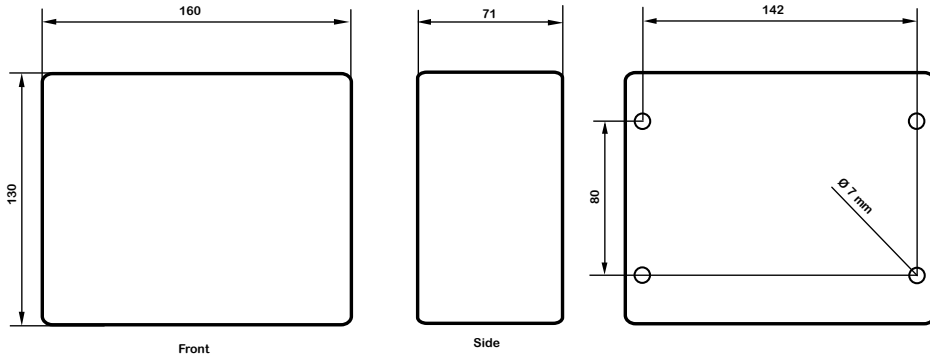

**HM-0461 LAD and HM-0462 LRS**

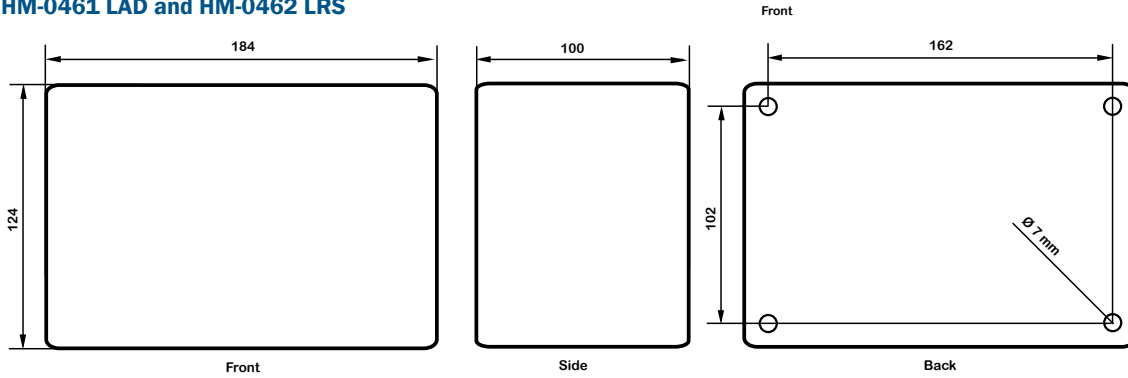

**HM-0478 Water sensor**

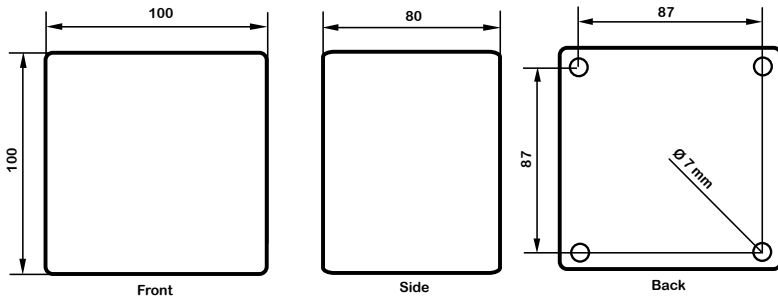

**HM-0479 Enclosure for water sensor**

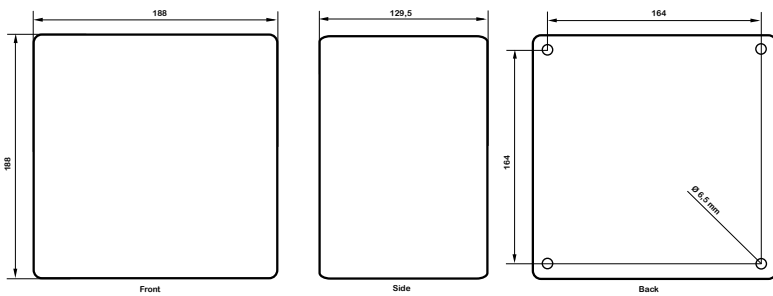

**HM-0420 ERU connector box metal and HM-0430 ERU connector box plastic**

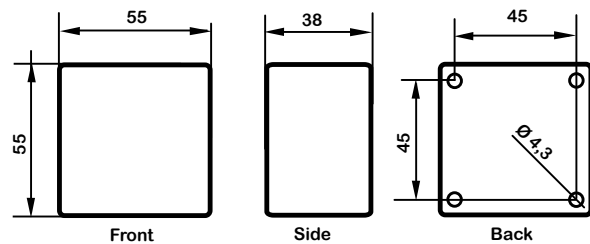

**HAMMAR<sup>®</sup>**

**[www.cmhammar.com](http://www.cmhammar.com)**

CM Hammar, August Barks Gata 15, 421 32 V. Frölunda (Göteborg) Sweden.  
Phone +46 31 709 65 50, Fax +46 31 49 70 23, [info@cmhammar.com](mailto:info@cmhammar.com)